

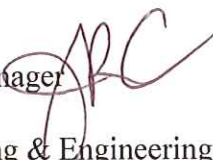

**SHAKOPEE PUBLIC UTILITIES
MEMORANDUM**

TO: John Crooks, Utilities Manager 
FROM: Joseph D. Adams, Planning & Engineering Director 
SUBJECT: Electric Service Rules and Regulations
DATE: October 12, 2018

ISSUE

The attached Electric Service Rules and Regulations are submitted for Commission review and approval.

BACKGROUND

For several years, staff has been working to create acceptable documentation of the Commission's electric service policies to be made available to the public in an easy to read publication similar to the existing Water Service Policy Manual.

Staff sought out permission from and acknowledges the assistance of the staff at Rochester Public Utilities for allowing us to use their manual as a starting point and template.

Various SPU staff that have worked on this effort over time include past Project Engineer Jerry Kuennen, Engineering Coordinator Richard Wolfe, Electric Superintendent Marv Athmann and Assistant Superintendent Kent Sanders. More recently, current staff Project Engineer Christian Fenstermacher, Electric Superintendent Greg Drent, Customer Service Director Sharon Walsh and Administrative Assistant Jennifer Eckers have been instrumental in helping create the finished document being submitted.

DISCUSSION

The Electric Service Rules and Regulations once adopted will serve the purpose of providing guidance to property owners, land developers, builders, electric contractors, most importantly customers and the general public and advise them of the Commission's policies and standards to receive electric service from Shakopee Public Utilities.

REQUESTED ACTION

Staff requests the Commission review the document and discuss any modifications or additional information that they may want to have staff incorporate in the final document prior to adopting the Electric Service Rules and Regulations by resolution.



SHAKOPEE PUBLIC UTILITIES

“Lighting the Way – Yesterday, Today and Beyond”

SHAKOPEE PUBLIC UTILITIES COMMISSION

ELECTRIC SERVICE RULES AND REGULATIONS

**Adopted by:
S.P.U.C. Resolution #
Dated**

SHAKOPEE PUBLIC UTILITIES
ELECTRIC SERVICE RULES AND REGULATIONS

October 15, 2018

INTRODUCTION

Shakopee Public Utilities (hereafter referred to as SPU) has assembled this booklet to assist its customers and their architects, engineers, or contractors to plan for and obtain electric service. This document will be reviewed and updated at least annually.

The information presented here is intended to supplement the requirements of the National Electrical Code (NEC), current edition, and all other applicable federal, state, and municipal codes, regulations, laws and ordinances. It is the customer's responsibility to refer to and comply with such other codes, regulations, laws, and ordinances when planning, designing, and installing an electrical service. Specific requirements of SPU do not intentionally conflict with any other requirements known to be in effect as of the publication date of the document. Any apparent conflicts of this nature should be brought to the attention of SPU for interpretation.

SPU wishes to serve its customers promptly and satisfactorily. We will endeavor to cooperate with customers and their representatives to the fullest extent possible in providing electrical service with as little delay and inconvenience as possible.

SPU will be happy to confer with those customers desiring information concerning rates, services, etc., by telephone or otherwise. Such inquiries can be made by phoning SPU's Customer Service Department at 952-445-1988 or by visiting the SPU Service Center located at 255 Sarazin Street, Shakopee, MN.

These rules and regulations are available on the SPU website at spucweb.com.

SHAKOPEE PUBLIC UTILITIES COMMISSION

ELECTRIC SERVICE RULES AND REGULATIONS

Adopted by:
S.P.U.C. Resolution #
Dated

**SHAKOPEE PUBLIC UTILITIES COMMISSION
ELECTRIC SERVICE RULES AND REGULATIONS**

TABLE OF CONTENTS

	Page No.
Introduction	2
Table of Contents	4
Section 100 Definitions	5
Section 200 General Information	10
Section 300 Rates, Connection Charges, and Credit Policy	17
Section 400 Standard Services	22
Section 500 Special Services	27
Section 600 Metering	32
Section 700 Customer Utilization Equipment	41
Section 800 Overhead Secondary Service	47
Section 900 Underground Secondary Service	51
Section 1000 Primary Service	56
Appendix Drawings	59
1. Multiple Metering Installation	
2. Smart Switch	
3. Typical Overhead Service	
4. Typical Underground Service	
5. Conduit Crossings	
6. Typical Joint Trench Layouts	
7. Conduit Placement	
8. Transformer Minimum Distances	
9. Clear Zones Around Pad-Mounted Equipment	
A. Summary of Developer Requirements for Electric Service	
B. Summary of Property Owner Requirements for Electric Service	
C. Summary of Customer Requirements for Electric Service	

**SHAKOPEE PUBLIC UTILITIES COMMISSION
ELECTRIC SERVICE RULES AND REGULATIONS**

SECTION 100 – DEFINITIONS

**Adopted by:
S.P.U.C. Resolution #
Dated**

**SHAKOPEE PUBLIC UTILITIES COMMISSION
ELECTRIC SERVICE RULES AND REGULATIONS**

SECTION 100

Index

DEFINITIONS	Page No.
• Application for Service	7
• Accessible	7
• Approved	7
• Connected Load	7
• Customer	7
• Customer's Service Equipment	7
• Disconnection Means	7
• Distribution Lines	7
• Dwelling	7
• Electric Service	7
• Fault Current	7
• Meter Set	8
• National Electrical Code	8
• National Electrical Safety Code	8
• Overhead Distribution Area	8
• Point of Delivery	8
• Property Owner	8
• SPU	8
• SPUC	8
• Rate Schedule Classification	8
• Secondary Terminal	8
• Service	8
• Service Drop	8
• Service Entrance Conductors, Overhead System	8
• Service Entrance Conductors, Underground System	9
• Service Equipment	9
• Service Lateral	9
• Type of Service	9
• Temporary Service	9
• Underground Residential Distribution (URD) Areas	9
• Voltage (of a Circuit)	9
• Voltage, Nominal	9
• Voltage to Ground	9

SECTION 100

DEFINITIONS

Application for Service: The agreement or contract between SPU and the Customer under which electric service is supplied and taken.

Accessible: An area that can be readily and safely accessed through a doorway, ramp, window, or stairway by a person on foot who exerts neither extraordinary effort nor employs special tools or devices to gain entry.

Approved: Acceptable to the authority having jurisdiction.

Connected Load: The combined manufacturer's rated loads of all motors and other electric energy consuming devices on the Customer's premises which may, at the will of the Customer, be operated with the electric energy supplied from the service of SPU.

Customer: An individual, partnership, corporation, or other legal entity now being served or to be served, using the electric service of SPU, at any specified location.

Customer's Service Equipment: The necessary equipment and accessories, located near the point of entrance of supply conductors to a building, which constitute the main control and means of disconnecting the supply to that building. This equipment usually consists of a circuit breaker or a switch and fuses.

Disconnection Means: A device, or group of devices, or other means by which the conductors of a circuit can be disconnected from their source of supply.

Distribution Lines: SPU's lines located along and under streets, alleys, highways, or easements on private property, when used or intended for use for general distribution of electric service to Customers of SPU.

Dwelling:

Dwelling Unit: One or more rooms for the use of one or more persons as a housekeeping unit with space for eating, living, and sleeping, and permanent provisions for cooking and sanitation.

One-Family Dwelling: A building consisting solely of one dwelling unit.

Two-Family Dwelling: A building consisting solely of two dwelling units.

Multi-Family Dwelling: A building containing three or more dwelling units.

Electric Service: The availability of electric power and energy, regardless of whether any electric power and energy is actually used. The supplying of electric service by SPU consists of maintaining, at the point of delivery, approximately the agreed voltage, phase, and frequency by means of facilities adequate for carrying the load that SPU is thereby obligated to supply by reason of the known requirements.

Fault Current: The current that will flow through the system to a point where a piece of equipment or a conductor has failed, such as bare conductors touching together or a bare conductor touching a ground point.

Meter Set: An instrument or instruments, together with auxiliary equipment, for measuring the electric power and energy supplied to a Customer.

National Electrical Code: The current edition of the National Electrical Code (NEC) as issued by the National Fire Protection Association (NFPA No. 70).

National Electrical Safety Code: The current edition of the National Electrical Safety Code (NESC) as issued by the Institute of Electrical and Electronic Engineers (IEEE) and adopted by the American National Standards Institute (ANSI C2).

Overhead Distribution Area: The area or areas served by SPU's overhead distribution system as differentiated from those areas served by underground systems.

Point of Delivery: The point where the electric energy first leaves the line or apparatus owned by SPU and enters the line or apparatus owned by the Customer unless specified in the Customer's Agreement for Service. This is not necessarily the point of location of SPU's meter.

Property Owner: An individual, partnership, corporation, or other legal entity who is the owner of record for the specified service location.

SPU: Shakopee Public Utilities is the electric and water utility owned by the City of Shakopee that serves in Shakopee and certain adjacent communities.

SPUC: The Shakopee Public Utilities Commission is a five-person public body whose members are appointed by the city council. The commission sets policy for the electric and water utilities owned by the City of Shakopee.

Rate Schedule Classification: The classification of the use of electricity into categories considering the amount of power supplied and the purpose of its use.

Secondary Terminal: The secondary side of a pad mounted transformer or a secondary junction box, whichever is designated by SPU.

Service: The conductors and equipment for delivering energy from SPU's system to the wiring of the Customer.

Service Drop: The overhead service conductors from the last pole or other aerial support up to and including the splices, if any, connecting to the service-entrance conductors at the building or other structure.

Service Entrance Conductors, Overhead System: The conductors between the terminals of the service equipment and a point usually outside the building, clear of building walls, where joined by tap or splice to the service drop.

Service Entrance Conductors, Underground System: The conductors between the terminals of the service equipment and the point of connection to the service lateral.

Service Equipment: The necessary equipment, usually consisting of a circuit breaker or switch and fuses, and their accessories, located near the point of entrance of supply conductors to a building or other structure, or an otherwise defined area, and intended to constitute the main control and means of cutoff of the supply.

Service Lateral: The underground service conductors from SPUC's distribution system, including any risers at a pole or other structure or from a transformer, to the first point of connection with the service entrance conductors in a terminal box or meter or other enclosure inside or outside the building wall. Where there is no terminal box, meter, or other enclosure, the point of connection shall be considered to be the point of entrance of the service conductors into the building.

Type of Service: The characteristics of electric service described in terms of frequency, phase, nominal system voltage, and number of wires.

Primary Service: Any type of service with a nominal voltage greater than 600 volts.

Secondary Service: Any type of service with a nominal voltage less than or equal to 600 volts.

Temporary Service: Service provided for a finite period of time, usually during the construction of permanent facilities when the permanent service is not yet completed. See Section 500 Special Services.

Underground Residential Distribution (URD) Areas: Those residential subdivisions or other specified areas within which all customers are served by underground distribution lines.

Voltage (of a Circuit): The greatest root-mean-square (effective) difference of potential between any two conductors of the circuit concerned.

Voltage, Nominal: The value, expressed in volts, which is assigned to a circuit or system for the purpose of designating its voltage class (as 240/120, 208Y/120, 480Y/277, etc.). The actual voltage at which the circuit operates can vary from the nominal within a range that permits satisfactory operation of equipment.

Voltage to Ground: The voltage between the given conductor and that point or conductor of the circuit that is grounded.

SHAKOPEE PUBLIC UTILITIES COMMISSION
ELECTRIC SERVICE RULES AND REGULATIONS
SECTION 200 – GENERAL INFORMATION

Adopted by:
S.P.U.C. Resolution #
Dated

**SHAKOPEE PUBLIC UTILITIES COMMISSION
ELECTRIC SERVICE RULES AND REGULATIONS**

SECTION 200

Index

GENERAL INFORMATION		Page No.
201	Service Jurisdiction	12
202	Application for Service	12
203	Ownership of Equipment	13
204	Easements	13
205	Inspection of Customer's Facilities	13
206	Service Connection, Disconnection, and Reconnection	14
207	Liability	15
208	Service Interruptions	15
209	Access	15
210	Customer Responsibility	15
211	Use of SPU Distribution Plan	16
212	Revision of Requirements	16

SECTION 200

GENERAL INFORMATION

201 Service Jurisdiction

SPU has been established for the purpose of providing electric and water service to properties within the City of Shakopee. SPU also provides electric service to properties outside the city limits of Shakopee but within the service area boundaries established by the State of Minnesota. Service will be provided to all eligible applicants when all applications, agreements, easements, deposits, payments, and other required information have been provided to SPU.

202 Application for Service

Application for new, additional, or temporary electric service must be made by the Customer, or a designated representative, to SPU at the service center located at 255 Sarazin Street, Shakopee, MN, or by fax at 952-445-7767. The Application for Utilities may be downloaded from the SPU website at spucweb.com. At the time of application, the Customer will be required to provide information relating to the service request, including the following:

- 1) Exact location of premises to be served including building street address or legal description, lot and block numbers, and name of the subdivision.
- 2) The type of service desired (temporary or permanent, residential, commercial, industrial, rewire, etc.)
- 3) For any commercial or industrial service, the service voltage, phases, connected load, and anticipated peak demand must be provided. Additional information in the form of construction drawings and the proposed service entrance may also be necessary for SPU to adequately determine the capacity and arrangement of service. This information must be received by SPU before the necessary planning and design of the project can be completed.
- 4) The approximate date that service is requested.
- 5) The name, address, and telephone number of the Customer's designated representative(s) who will be responsible for working with SPU representatives in providing the electric service. Only the designated representative(s) will have access to account information. All designated representatives hold the same financial responsibility for the account. Once identified as a designated representative, only

the remaining, responsible representative can remove another representative from the account.

- 6) Deposits may be required. See Section 306 for details.

203 Ownership of Equipment

203.1 SPU-Owned Equipment - The meter and associated metering equipment furnished and installed by SPU remains the property of SPU.

203.2 Customer/Property Owner-Owned Equipment - The meter socket, metering transformer compartment, if required, service entrance conductors and conduit from the meter socket to the service entrance disconnect, the service entrance switch or circuit breaker, and the service entrance ground equipment are all the property of the Customer.

- 1) Overhead Service – In addition to the equipment on the Customer side of the meter socket, the service drop with wire holder or bracket, the weather head and either the service mast and conduit with entrance wires or the service entrance cable with watertight connection to the meter socket are the property of the Customer.
- 2) Underground Service – In addition to the equipment on the Customer side of the meter, all conduit and cable required to extend the secondary service lateral from SPU’s secondary terminals to the meter socket are the property of the Customer.

The Customer and SPU are responsible for the installation, maintenance, repair, and replacement of the electric service equipment which each owns.

204 Easements

Whenever any SPU-owned overhead and underground lines and equipment is located on the Customer’s property, the Customer shall grant an easement to SPUC to the extent SPUC deems necessary. All utility easements required by SPUC are to be granted by the Customer at no cost to SPU. The Customer must provide a legal description by a Registered Land Surveyor. The easement will be accepted and recorded by SPU.

205 Inspection of Customer’s Facilities

205.1 As a minimum, wiring and electrical equipment installed and owned by the Customer shall be installed in accordance with the latest edition of the National Electrical Code (NFPA No. 70). State law permits a homeowner to complete the wiring in his own home, however, SPU will

not make a service connection prior to inspection if the wiring was completed in this manner. All homeowner-completed wiring must be inspected by the designated electrical inspector prior to connection.

205.2 Wiring installations within the Shakopee city limits, including temporary installations, must be inspected and approved by an authorized electrical inspector employed by the City of Shakopee as required by Shakopee City Ordinance No. 4.19. SPU will make connection only after approval by the inspecting authority. The electrical inspector is required by City Ordinance to disconnect or have disconnected by SPU any installation that is declared by the electrical inspector to be unsafe and a hazard.

205.3 Customers outside the Shakopee city limits requesting service from SPU must have their wiring inspected by the state inspector prior to the service being energized. SPU will make connection before authorization from the state inspector only if the wiring was completed by a licensed electrician or contractor whose name is listed on the certificate.

206 Service Connection, Disconnection, and Reconnection

206.1 New Service - A meter will be installed by SPU and electric service made available within 2 business days after all applications, agreements, payments, deposits, and the certificate of connection (electrical permit) have been received provided the service has been inspected and SPU's distribution system extension is completed. The SPU Service Center is located at 255 Sarazin Street, Shakopee, MN. The phone number is 952-445-1988, fax number 952-445-7767.

206.2 New Customer at an Existing Location - A request to provide electrical service into the name of a new tenant or owner for purpose of establishing a new account will normally require that a meter reading be obtained. Requests will include the completion of an Application for Service that must be received by SPU at least 2 business days before the intended time of assignment.

206.3 Disconnection and Reconnection of Existing Services - Customer requests for disconnection or reconnection of existing services for maintenance, construction, re-siding, or demolition reasons must be received by SPU at least 2 business days in advance of the desired time of disconnection or reconnection (weekends and holidays excluded). For mutual protection of the Customer and SPU, only authorized employees of SPU are permitted to set and remove meters, or to make or break the connection between SPU's service drop or secondary terminals and the Customer's service entrance conductors.

207 Liability

SPU does not engage in the practice of doing interior wiring on Customer's premises, except for the installation and maintenance of its own property. SPUC shall not be liable for damage to any Customer or to any third party resulting from use of the electric service or from the presence of SPU's equipment on the Customer's premises. The Customer is solely responsible for any accidents, fires, or failures resulting from the condition and use of his or her wiring installation or equipment.

208 Service Interruptions

SPU reserves the right to interrupt service at any time. Except for cases of extreme hazard to employees or the public, interruptions for maintenance and system improvement will be prearranged and advance notice will be given to the affected Customers.

SPU will not be responsible for consequential damages resulting from service interruptions, abnormal system conditions due to causes outside its control, or from operations in response to abnormal system conditions. Customers requiring service reliability and/or stability exceeding SPU's normal service should consider uninterruptible power supplies, isolation transformers, power conditioners, redundant services, or other options to provide the level of service needed. SPU's engineering staff (952-233-1501) is available to discuss such needs.

209 Access

The utility shall have the right of access to the Customer's/Property Owner's premises at all reasonable times for the purpose of installing, reading, inspecting, maintaining, or removing any of its meters, devices, or other equipment which is used in the provision of the Customer's electric service.

210 Customer Responsibility

Failure of the Customer to notify SPU in a timely manner of any planned alteration to electric service facilities or increased electrical load, and failure to comply with SPU's published rules, regulations, and rate schedules may result in delayed connections, interruption of service, discontinuation of service, or damage to equipment, for which SPU disclaims all responsibility.

211 Use of SPU Distribution Plant

SPU's poles and pad-mounted equipment are for its use only, unless a formal agreement has been executed with SPU for the attachment of other utility equipment. Signs may not be placed on SPU poles or pad-mounted equipment. Nails and staples used for placing signs on poles create a safety hazard for linemen when climbing the poles.

212 Revision of Requirements

All requirements stated or implied herein are subject to change without prior notice. Check website at spucweb.com for changes.

SHAKOPEE PUBLIC UTILITIES COMMISSION
ELECTRIC SERVICE RULES AND REGULATIONS

SECTION 300 – RATES, CONNECTION CHARGES, AND CREDIT POLICY

Adopted by:
S.P.U.C. Resolution #
Dated

**SHAKOPEE PUBLIC UTILITIES COMMISSION
ELECTRIC SERVICE RULES AND REGULATIONS**

SECTION 300

Index

RATES, CONNECTION CHARGES, AND CREDIT POLICY		Page No.
301	Rate Schedule Classification	19
302	Payment	19
303	Customer Charge	19
304	Underground Electric Charge	19
305	Service Disconnection/Reconnection	20
306	Service Deposit	20

SECTION 300

RATES, CONNECTION CHARGES, AND CREDIT POLICY

301 Rate Schedule Classification

Electric service is supplied to Customers under various rate schedule classifications as determined by the type of service, the amount of electric power supplied, and the purpose for which the electric service is to be used. Copies of SPU's rate schedules are available at SPU's Service Center or on our website (spucweb.com).

302 Payment

SPU will, insofar as possible, read all meters every month and bill the Customers for service used during the period. Payment of the bill is due on the 15th of the month, except when falling on a weekend or holiday, then the following business day. Payments received after the due date will be assessed a late payment fee and the account will be considered past due.

If the meter cannot be read during a billing period, or the reading seems erroneous, an estimate will be made for that billing period. If the meter cannot be read due to access issues, no more than two estimated billing cycles will be allowed. Adjustments to bills resulting from inaccuracies in the meters will be handled in the manner described in paragraph 608.

303 Customer Charge

There is a customer charge for each meter/service provided. The amount of this customer charge will vary based on the type of service provided.

304 Underground Electric Charge

SPU will charge an underground electric charge for the extension and connection of new or expanded underground electric service to any customer. The amount of the charge can be obtained from the Planning and Engineering Department.

There will be no charge for connections to existing services during SPU's normal working hours. If connection must be made outside of normal working hours at the request of the Customer, a special connection charge will be assessed. The charge for such work can be obtained from the Customer Service Representative.

305 Service Disconnection/Reconnection

SPU may disconnect a Customer's service, with notice, for any of the following reasons:

- Non-payment of billings or issuance of a non-negotiable check
- Non-payment of other charges/fees
- Failure to meet credit requirements
- Failure to provide access to SPU owned metering equipment

Without notice, the Customer's service may be disconnected for:

- A condition determined to be hazardous--to the Customer; to other Customers; or to SPU personnel or equipment
- Unauthorized use of electricity, water, or equipment belonging to SPU

In the event service has been disconnected for a valid cause, the Customer will be required to pay a reconnection fee before service is restored.

A schedule of fees is available from a SPU Customer Service Representative.

306 Service Deposit

306.1 A deposit shall be required to be paid by all residential customers who do not hold title to the real property at the customer's service address.

Residential rental customers will pay a standard deposit, higher if electric heat, prior to connection of services. Utility service will remain in the property owner's /landlord's name until the renter's/leaser's deposit requirement is satisfied in full. This refundable deposit and interest earned will be applied to any final bill charges as of the date of service disconnection. Any remaining credit balance will be refunded to the customer in the form of a refund check. If a balance due exists after the deposit has been applied, a final bill will be issued to the customer for payment.

For residential homeowners no deposit is required. However, if an account is shut off as a result of a delinquent balance, the Utility reserves the right to require a deposit prior to reconnection of service.

306.2 Commercial and industrial customers are required to pay a deposit, equal to two months average billings, prior to installation of permanent service. If no prior usage history is available you will be required to provide a load sheet, then the deposit will be based on this information. The deposit and/or guaranty will be retained by SPU until the service is disconnected.

You may select one of the three methods indicated for meeting the deposit requirement:

- Cash (interest accrued annually)
- Irrevocable letter of credit from a bank
- Surety bond

Deposit and interest will be applied to any final bill charges as of the date of service disconnection. Any remaining credit balance will be refunded to the customer in the form of a refund check. If a balance due exists after the deposit has been applied, a final bill will be issued to the customer for payment.

If the deposit has been held for 12 months or more, the customer has the right to request a recalculation of the deposit based on actual electricity usage. SPU will refund any over collection once current history is established.

**SHAKOPEE PUBLIC UTILITIES COMMISSION
ELECTRIC SERVICE RULES AND REGULATIONS**

SECTION 400 – STANDARD SERVICES

**Adopted by:
S.P.U.C. Resolution #
Dated**

**SHAKOPEE PUBLIC UTILITIES COMMISSION
ELECTRIC SERVICE RULES AND REGULATIONS**

SECTION 400

Index

STANDARD SERVICES		Page No.
401	General Characteristics	24
402	Availability of Service	24
403	Secondary Service Voltages	24
404	Primary Service Voltages	25
405	Operating Voltages	25
406	Street Lighting Service	25
407	Security Lighting Service	26

SECTION 400

STANDARD SERVICES

401 General Characteristics

This section describes the types of services offered to customers under SPU's Standard Rate Schedules. Electric service supplied by SPU is alternating current having a nominal frequency of 60 Hertz (cycles per second).

402 Availability of Service

Although the types of service listed below are generally available throughout the area served by SPU, service of the type requested by a customer may not be available at a location where such service is desired, and in certain cases may be available only through special contractual arrangements and at the expense of the customer. Each customer will generally be allowed only one type of service and point of connection at each location.

403 Secondary Service Voltages

The following types of secondary service are generally available to customers served under SPU's rate schedules:

403.1 Single Phase Service

- a) 240/120 Volt, 3-Wire, Grounded Neutral. Generally available where the total load is less than 75 kVA for pad-mount service, or less than 50 kVA for pole-mounted service.
- b) 480/240 Volt, 3-Wire, Grounded Neutral. Available for street lighting service only.

403.2 Three Phase Service

- a) 208Y/120 Volt, 4-Wire, Grounded Neutral. Generally available where facilities of adequate capacity are adjacent to the premises to be served. This service is limited to less than 500 kVA for pad-mounted service, or less than 150 kVA for pole-mounted service. When the necessary infrastructure is not in place to provide this service, special contract arrangements may be necessary before the service is provided.

b) 240/120 Volt, Delta, 4-Wire, Grounded Neutral. Available only where installed capacity exists. If expansion of existing service is necessary, customer shall convert service to 208Y/120 volt, 4-wire, grounded neutral.

c) 480Y/277 Volt, 4-Wire, Grounded Neutral. Generally available where facilities of adequate capacity are adjacent to the premises to be served. This service is limited to less than 2500 kVA capacity. When the necessary infrastructure is not in place to provide this service, special contract arrangements may be necessary before the service is provided. This type of service is not available for pole-mounted overhead services.

404 Primary Service Voltages

Service at primary voltage is available at either 13,800Y/7970 Volts or 12,470Y/7200 Volts, 4-Wire, Grounded Neutral. The available voltage depends on the SPU distribution circuit voltage in the area. This service is available by special request when the projected demand is greater than 500 kVA. SPU reserves the right to deny a request for primary voltage service. When the necessary infrastructure is not in place to provide this service, special contract arrangements may be necessary before the service is provided.

The Customer will provide and maintain a primary voltage metering cabinet in which to accept service. The cabinet will be the point of delivery.

405 Operating Voltages

The voltages indicated above are nominal service voltages. SPU will endeavor to maintain the actual service voltage within an operating range up to 5% above and 5% below these nominal service voltages. When the service voltage is found to be outside of the +/- 5% range, SPU will take the necessary steps to return the voltage to the operating range as soon as practical.

406 Street Lighting Service

Street lighting is provided in the City of Shakopee in accordance with the Street Lighting Policy established between the City of Shakopee and SPU. This policy provides for lights to be installed at street intersections and at regular intervals on both sides of city streets. The lighting level is generally higher on main and collector streets than on residential streets. Roadway lighting is provided as security lighting service in other governmental jurisdictions with separate agreements.

407 Security Lighting Service

Security lighting can be provided at the request of individual Customers in SPU's service territory. The cost of security lighting is borne by the requesting party. Contact SPU's Planning and Engineering Department to discuss the options available.

SHAKOPEE PUBLIC UTILITIES COMMISSION
ELECTRIC SERVICE RULES AND REGULATIONS
SECTION 500 – SPECIAL SERVICES

Adopted by:
S.P.U.C. Resolution #
Dated

**SHAKOPEE PUBLIC UTILITIES COMMISSION
ELECTRIC SERVICE RULES AND REGULATIONS**

SECTION 500

Index

SPECIAL SERVICES		Page No.
501	Temporary Service	29
502	Services for Unusual Load Characteristics	29
503	Redundant Facilities	30
504	Relocation or Protection of SPU Facilities	30
505	Rewiring Existing Facilities	30
506	Underground Locations	30

SECTION 500

SPECIAL SERVICES

501 Temporary Service

501.1 Temporary service is intended to be supplied at secondary voltages only to customers for use during the construction of permanent facilities and before the permanent service can be installed. Temporary service may also be provided for short-term events such as community celebrations and seasonal sales.

501.2 The address of the location to be supplied with temporary service must be permanently displayed at the location and on the temporary pedestal before SPU will install the temporary service. All overhead and underground temporary services will be metered and billed under one of SPU's Standard Rate Schedules. SPU will furnish only the overhead service drop or lateral and the metering equipment.

501.3 The Customer shall provide an approved meter socket with the necessary raceway and suitable rigid support for attachment of metering equipment and service drop or lateral. On all services requiring instrument transformers, the Customer shall furnish a suitable enclosure for the installation of SPU's transformers.

501.4 A nominal fee will be charged for the provision of temporary service. This charge is designed to cover SPU's cost for the installation and removal of the necessary temporary facilities. It will be determined in advance and must be paid before the service is connected.

Information regarding the charges for temporary service can be obtained from SPU's Electric Superintendent at 952-233-1502.

502 Services for Unusual Load Characteristics

The operation of Customer equipment having a relatively high load of short or intermittent duration, such as welders, compressor motors, elevators, and X-ray equipment, may cause serious fluctuations of voltage and interfere with the service being provided by SPU to other customers. If such a load is anticipated, the Customer must consult with SPU and agree to install such protective devices as may be required so as not to cause damage to any of SPU's equipment or in any way inhibit service to other customers. In addition, special compensation may be required by SPU from the Customer in those cases where it is necessary for SPU to install special or larger facilities than would normally be required to provide satisfactory service.

503 Redundant Facilities

SPU will normally provide one set of facilities to one point of service for each Customer. If a Customer requires redundant facilities, SPU must be advised as soon as possible so the feasibility of such service can be determined. If SPU determines that redundant facilities can be provided, the Customer will be required to reimburse SPU for the entire cost of the additional facilities including labor, materials, vehicle charges, and overhead. An agreement between the Customer and SPU shall also be executed.

504 Relocation or Protection of SPU Facilities

It is the responsibility of the Customer to arrange for the relocation and/or protection of SPU's facilities whenever such action is appropriate. Any intended relocation or protection of SPU facilities must be reviewed with and approved by SPU in advance. The cost of any change or relocation of SPU's facilities for the benefit only of the Customer, and which has been initiated by the Customer, shall be borne solely by the Customer. A deposit by the Customer may also be required before the changes are made. SPU will bear costs to the extent (as determined by SPU) that the change or relocation benefits SPU.

505 Rewiring Existing Facilities

The Customer or electrical contractor shall contact SPU when it is necessary to rewire or upgrade an existing electric service. All SPU Electric Rules and Regulations will be followed to the degree that conditions allow, with final approval by SPU personnel. The Customer shall be responsible for maintaining the same phase rotation for 3-phase rewires.

When customer has 240/120 volt, delta service per section 403.2.b and customer is making upgrades to service, customer shall upgrade service to a 208Y/120 volt service per section 403.2.a.

506 Underground Locations

506.1 Minnesota Statute, Chapter 216D, requires an excavator to contact the utility notification center (Gopher State One Call) at least 48 business hours before beginning an excavation. SPU encourages that underground facilities locations be requested prior to all construction or activity that disturbs the soil. The excavation notice may be made by calling the center at 811 or www.gopherstateonecall.org and providing the following information:

- Name of individual calling.
- Precise location of the proposed excavation.
- Name, address, and telephone number of the excavator.
- Excavator's field phone number.
- Type and extent of proposed excavation.
- Any anticipated use of explosives.
- Date and time when excavation is to commence.

506.2 "Excavation" means an activity that moves, removes, or otherwise disturbs the soil by use of a motor, engine, hydraulic or pneumatically powered tool, or machine-powered equipment of any kind, or by explosives.

Excavation does not include:

- The extraction of minerals.
- The opening of a grave in a cemetery.
- Normal maintenance of roads and streets if the maintenance does not change the original grade and does not involve the road ditch.
- Plowing, cultivating, planting, harvesting, and similar operations in connection with growing crops, trees, and shrubs, unless any of these activities disturbs the soil to a depth of 18 inches or more.
- Gardening, unless it disturbs the soil to a depth of 12 inches or more.
- Planting of windbreaks, shelterbelts, and tree plantations, unless any of these activities disturbs the soil to a depth of 18 inches or more.

506.3 Any contact with an electric cable during excavation must be reported immediately, day or night, by calling SPU at 952-445-1988.

**SHAKOPEE PUBLIC UTILITIES COMMISSION
ELECTRIC SERVICE RULES AND REGULATIONS**

SECTION 600 – METERING

**Adopted by:
S.P.U.C. Resolution #
Dated**

**SHAKOPEE PUBLIC UTILITIES COMMISSION
ELECTRIC SERVICE RULES AND REGULATIONS**

SECTION 600

Index

METERING	Page No.
601 Responsibilities for Providing Metering Equipment	34
602 Location of Meters	34
603 Meter Excavation, Clearances, and Accessibility Requirements	35
604 Additional Requirements	35
605 Meter Identification	36
606 Meter Mounting	36
607 Meter Connections	36
608 Meter Testing	37
609 Meter Tampering	37
610 Services Requiring Instrument Transformer Installation	38
611 Use of Bypass Socket	38
612 Master Metering	39
613 Location of High-Leg in Meter Socket-240/120 Volt 3 Phase Service	39
614 Removing SPU Seals and Meters	39
615 Customer Generation	39
616 Proper Grounding	39
617 Customer Disconnect Switch	40
618 SPU-Owned Equipment	40

SECTION 600

METERING

This section covers the installation of meters and the associated equipment necessary to measure Customer's usage for both overhead and underground service.

601 Responsibilities for Providing Metering Equipment

All metering equipment except current and potential transformers must be provided and installed by the customer or their contractor. For secondary service, SPU will provide and the Customer will install the current transformers, when required. For primary service, SPU will provide and install the current and potential transformers. All metering equipment installed must be UL listed and labeled and have prior approval of the SPU electric department. Metering equipment installed without SPU approval will not be energized unless by special permission of the SPU electric department. SPU will energize only one set of metering equipment under each contract or application for one class of service.

602 Location of Meters

Meter locations will be agreed upon by the Customer and SPU, subject to final approval by SPU.

602.1 Residential – All new or rewired services must have the meter located outside. Prior written approval from SPU is needed to be excluded from this requirement.

602.2 Multiple Tenant Dwellings – When more than one meter is installed, as in the case of a twin home or an apartment complex, meters are to be located outside and grouped where possible. Exception: Complexes that have 24 or more meters may locate them inside as long as they are grouped at one location and accessible at all times to each customer and SPU personnel. Drawing No. 1 in the Appendix shows a typical multiple-meter installation.

602.3 Industrial and Commercial – Meters for commercial and industrial services shall be located outdoors in an area that is easily accessible at all times to SPU personnel.

603 Meter Elevation, Clearances, and Accessibility Requirements

603.1 Height Limits – All meters shall be mounted 3-6 feet from final grade to the center of the meter. Where indoor meter installations are permitted, the bottom meter may be 2 feet above the floor.

603.2 Meter Clearances – Meters shall be situated such that there is not less than three feet of unobstructed space in front and one foot on all sides of the meter face; this applies to landscaping material. It is the customer's responsibility to establish and maintain the required clearances. Meters shall not be located where they are subject to corrosive fumes, excessive dust, vibration, excessive noise or physical damage. Outdoor meters shall not be located in carports, under porches or decks whether open or closed, or along walkways or driveways where they might be create a hazard to pedestrians or vehicles.

603.3 Access to Meters – Meters shall be located where they are readily and safely accessible to SPU personnel at all times, even with loss of power. The building owner shall provide, by means of a lock box on the premises, a key to gain access to the meters. Meters shall not be located where ladder climbing is required, under a porch or deck, in any location where the clearance is less than 7', including plants and shrubs, or in any location where damage is likely to occur.

604 Additional Requirements

604.1 Apartment Buildings - Individual apartment disconnects must be connected on the load side of the meter. If the service voltage is 208/120 volts, a fifth terminal located at the 9 o'clock position is required in the socket and must be connected to the service neutral in accordance with the National Electrical Code. Only one meter may be installed under one socket cover in multi-metering panels. The maximum height to the center of the top meter shall be no more than 6 feet and the minimum height to the center of the bottom meter shall be 3 feet, 2 feet when permitted indoors.

604.2 Commercial Multi-Metering Panels – All commercial multi-metering panels shall have a maximum of 4 meter sockets per vertical stack. The maximum height to the center of the top meter shall be no more than 6 feet and the minimum height to the center of the bottom meter shall be 3 feet, 2 feet when permitted indoors. Each individual unit disconnect shall only be connected to the load side of the meter. Only one meter may be installed under one socket cover. A system neutral is required to each 5 and 7 terminal meter socket in accordance with the National Electrical Code.

605 Meter Identification

In multiple-dwelling or multiple-tenant installations, the building owner shall ensure that each individual meter socket shall have an identification tag with the appropriate address, unit number, or suite number for the unit being metered. This tag shall be a durable engraved metal or plastic tag that is riveted, screwed, or bolted in place. A similar tag shall also be placed on the cover. Each circuit shall be carefully traced and rechecked by the Customer to ensure against errors in wiring that would result in one customer obtaining service through the meter serving another customer. This is especially important when the wiring is concealed. The service shall not be energized if meter sockets are not identified. It will be the building owner's responsibility to correct any errors due to mis-identification of meter sockets.

606 Meter Mounting

606.1 Outdoor meters and meter mounting devices shall be mounted securely on permanent structures such as houses, garages, or other buildings. Where outdoor meters are installed on surfaces that prevent installation of the meter mounting device in an exact vertical plane, a meter board must be installed or the surface modified in such a manner that the meter mounting device can be installed vertically. The preferred meter location is within ten feet of the front of the building. All meter locations for rewired or upgraded services shall be located outdoors with locations agreed upon by the Customer and SPU with final approval by SPU. SPU has the right to refuse to energize a service if these requirements have not been met.

606.2 Indoor meters, **where permitted**, shall be mounted in accordance with the preceding requirements of this section and shall be located as close as possible to the point where service enters the building. Indoor metering equipment shall be mounted securely in a vertical plane on a permanent structure in a location free from moisture, high temperature, vibration, excessive noise, excessive dust or dirt.

607 Meter Connections

The Customer shall provide the necessary wiring for the meter set with the wiring so arranged that the line (supply) side is connected to the top terminals of the socket and the load side to the bottom terminals. All neutral conductors must be insulated. For underground services, the line side neutral wire is to be identified in accordance with the National

Electrical Code. There should be sufficient slack left in the underground cables to make up for any ground shifting that may occur.

608 **Meter Testing**

Any Customer who believes that their meter is failing to properly register the use of electricity may request a meter check by contacting the Customer Service Department. SPU will test the meter using standard calibration equipment and generally accepted test procedures within a reasonable period of time. A standard fee will be charged for this test. The fee will be waived if the meter is found to be inaccurate.

Whenever a watt-hour meter is found upon test to have an average error of more than two percent (2%) from one hundred percent (100%) or a demand meter more than one and one half percent (1.5%) from one hundred percent (100%), a recalculation of bills for service will be made on the basis that the meter should be one hundred percent (100%) accurate with respect to the working test standard.

If the period of inaccuracy cannot be determined, it will be assumed that the metering equipment has become inaccurate at a uniform rate since it was installed or last tested unless there is valid reason to use another method. Recalculation of bills is based on SPU Policy for adjustments of customer accounts.

When the average error cannot be determined by test due to complete failure of all or part of the metering equipment, then an estimate of the quantity of energy consumed based on available data will be used to determine the adjusted bills.

609 **Meter Tampering**

All connections to SPU's service equipment shall be made by SPU personnel only. **Unauthorized connections to or tampering with any SPU meter, associated equipment or meter seals, or indications or evidence thereof subjects the Customer to immediate discontinuance of service, prosecution under the laws of the State of Minnesota, adjustment of prior bills for services rendered, payment of the tampering fee as adopted by SPUC and reimbursement to SPU for all extra expenses incurred on the account.** In addition, when the unauthorized connections or tampering involve an inside meter, the Customer shall, at his/her own expense, relocate all service equipment and metering facilities on the outside of the building.

610 Services Requiring Instrument Transformer Installation

610.1 Secondary Voltage Customers - Any single phase service having a total connected load greater than 320 amperes, and any three phase service having a total connected load greater than 200 amperes will require instrument transformers for the metering installation. These instrument transformers will be furnished by SPU and installed by the Customer on the line side of the service entrance disconnect switch. An exception may be made to this rule in the case of a multi-tenant building.

Instrument transformers shall be installed in an approved current transformer cabinet; in the connection cabinet, if used, located adjacent to SPU's transformer; or in the Customer's switchgear in a compartment designated for instrument transformers. All cabinets used must be UL approved and must meet all applicable NEC and NEMA class rules for the environment in which they are located. Cabinets must accept bar type current transformers. Instrument transformers may not be installed in pad-mount transformer cabinets. No open air instrument transformers will be permitted for an overhead service. The location of the instrument transformers must be approved by SPU. The customer must furnish and install a 1-inch rigid metal conduit from the instrument transformer location to a meter location approved by SPU. Conduit runs shall not exceed 25 feet, except by special permission.

610.2 Primary Voltage Customers - All primary voltage Customers require instrument transformers for both voltage and current. If indoors, the instrument transformers should be located in a switchgear compartment or cubicle designed for that purpose. If the instrument transformers are located outdoors, they may be mounted in a pad-mounted cabinet designed for that purpose.

611 Use of Bypass Socket

An approved lever-operated bypass socket shall be provided and installed by the Customer for all self-contained (without instrument transformers) metering installations. Such sockets permit a continuation of service upon removal of the meter for testing or maintenance. If a lever-operated bypass socket is not installed, the service will not be energized.

All self-contained meter sockets must have a minimum rating of 200 amperes continuous. Contact SPU's Customer Service Department for a current list of approved meter sockets.

612 Master Metering

All new residential units will be individually metered with the exception of facilities that provide care for elderly or disabled persons as provided for in State Law (16B.61 Subd.8). In mobile home parks, a master meter may be used but all billing will be administered via master meter. All new commercial and industrial customers will be individually metered.

613 Location of High-Leg in Meter Socket on 240/120 Volt 3 phase Service

The conductor with the higher voltage to ground must be connected to the terminal on the right side. The high-leg conductor must be identified as required by the National Electrical Code. Meter sockets with the high-leg in the wrong position will not be energized. Incorrectly wired sockets will be subject to disconnection until wiring is corrected.

614 Removing SPU Seals and Meters

Disconnection of SPU metering equipment and cutting of seals is not allowed without obtaining prior approval from the Electric Service Department.

615 Customer Generation

Where a customer intends to operate any type of electric generator, photovoltaic array, wind generator, or similar equipment interconnected to the SPU system, special service and metering requirements must be satisfied. Contact SPU's Planning and Engineering Department for details prior to interconnecting any generation equipment. Before a customer generator may be connected to operate in parallel with the SPU distribution system, the customer must request approval from SPU for this type of operation. The design of this interconnection must include relay protection to prevent damage to the utility system as required by the current version of the State of Minnesota Requirements for Interconnection of Distributed Generation.

616 Proper Grounding

All metering conduits and sockets must be properly grounded. Electric service will not be connected to improperly grounded equipment.

A system neutral is required to each 5 and 7 terminal socket. Conductor should be sized in accordance with the National Electrical Code.

617 Customer Disconnect Switch

Individual customer disconnect switches should be connected on the load side of the meter. No customer devices such as surge suppressors or load management equipment may be installed on the line side of the meter.

618 SPU-Owned Equipment

Any metering equipment furnished by SPU such as meters, instrument transformers, relays, totalizers, test switches, etc. remain the property of SPU. If the equipment has to be removed or disconnected for any reason, please call SPU so that the equipment can be picked up.

SHAKOPEE PUBLIC UTILITIES COMMISSION
ELECTRIC SERVICE RULES AND REGULATIONS
SECTION 700 – CUSTOMER UTILIZATION EQUIPMENT

Adopted by:
S.P.U.C. Resolution #
Dated

**SHAKOPEE PUBLIC UTILITIES COMMISSION
ELECTRIC SERVICE RULES AND REGULATIONS**

SECTION 700

Index

CUSTOMER UTILIZATION EQUIPMENT		Page No.
701	Protection of Customer Equipment	43
702	Motor Starting Currents	44
703	Power Factor	44
704	Fault Currents	44
705	Customer-Owned Generating Equipment	44
706	Energy Conservation	45
707	Customer's Obligation	45

SECTION 700

CUSTOMER UTILIZATION EQUIPMENT

The Customer's service entrance and utilization equipment shall be installed in accordance with all local, state, and National Electrical Code requirements. It is the intent of this section to provide the Customer with recommendations concerning factors that can affect both SPU and the Customer in the selection, installation, maintenance, and operation of the Customer's utilization equipment. If concerns arise that are not covered in this section, SPU's Customer Service Department should be contacted.

701 Protection of Customer Equipment

The customer is advised to provide adequate protection against the effects of outages or voltage spikes in accordance with the NEC or other pertinent sources of information for all types of motors and other equipment.

Equipment that should be protected includes, but is not limited to:

- motors
- computers
- electronics equipment
- equipment in which computers or electronics form an integral operating part

Equipment should be protected under all conditions, including:

- overload
- loss of voltage
- high or low voltage
- loss of phase(s) (e.g. single phasing on polyphase motors)
- re-establishment of service after any of the foregoing
- phase reversal
- motors that cannot be subjected to full voltage on starting
- harmonics or wave form irregularities

Failure to provide such protection may result in needless damage to equipment and the expense of delay and repair. Sensitive electronics, such as microprocessor-based home electronics and business computers, are susceptible to damage due to voltage spikes or surges.

Wiring practices that meet manufacturer specifications need to be assured in the installation of any microprocessor-based electronics. (For example, proper grounding and dedicated circuits are important.) Consideration should be given to installing transient voltage surge suppression equipment at the main service entrance and at the point of use. An

uninterruptible power supply should be considered if a momentary voltage dip or outage would cause loss of data.

702 Motor Starting Currents

All motors require a starting current substantially greater than their normal running current. Where starting currents are excessive, an abnormal drop in supply voltage will result. In order to minimize the unfavorable effects of such voltage drops, it is essential that the Customer's motors not exceed the allowable starting characteristics as shown in current version of the National Electrical Code.

Customers planning to install any motor larger than 5 horsepower single phase or 25 horsepower three phase must contact SPU's Planning and Engineering Department. Motor installations that cause power quality problems for other Customers shall be corrected at the owner's expense.

703 Power Factor

In order to improve the efficiency of SPU's distribution system, the Customer's utilization equipment shall maintain an average power factor as close to unity as possible, and never leading. Some of SPU's rate schedules include a demand charge and a penalty for an average power factor that is less than 90% lagging. Details of the method of billing for such Customers can be obtained from the Customer Service Department. For new services, it is suggested that the Customer's utilization equipment be designed to include provisions for adding capacitors in order to improve the average power factor. SPU will install metering equipment to measure the average power factor.

704 Fault Currents

The Customer's service equipment and other devices shall be adequate to withstand and interrupt the maximum available fault current. For single family residences with service equipment rated 200 amperes maximum and 240/120 volts single phase, equipment shall have a minimum interrupting rating of 10,000 amperes symmetrical and other equipment shall be braced to withstand that minimum value. Contact the SPU Planning and Engineering Department to determine fault current availability for other services.

705 Customer-Owned Generating Equipment

Unless authorized by written agreement, electric generating equipment installed by the Customer shall not be interconnected or operated in parallel with the SPU system. The Customer shall own, install, operate,

and maintain electrical interlocking equipment which will prevent parallel operation and such equipment shall be approved by SPU prior to installation.

706 Energy Conservation

SPU encourages the prudent and efficient use of the electric energy which it provides. Customers desiring special information or assistance regarding the efficient use of electricity should contact the Marketing Department.

SPU offers a residential program to control the peak demand during times of heavy usage. This is accomplished by cycling off air conditioning load in those homes equipped with a Smart Switch. Customers who participate in this voluntary program are given a credit on their bills during the months of June through September. Drawing No. 2 in the Appendix shows a typical Smart Saver switch installation.

707 Customer's Obligations

707.1 Increased Load. In the event the Customer desires to significantly increase load, (more than 10%) they shall provide SPU notice as soon as possible so that SPU can provide added facilities, if necessary. If additional facilities are necessary, there may be a contribution in aid of construction required from the Customer. If the Customer fails to notify SPU of added load and SPU's equipment is damaged as a result of such added load, the Customer shall reimburse and make payment to SPU for all such damages.

707.2 Balancing the Load. Except in the case of a three-phase four wire delta service, the current unbalance in three-phase services shall not exceed 10 percent of the current that would be required at maximum load under balanced conditions.

707.3 Total Harmonic Distortion. The application of any nonlinear loads by the Customer such as static power converters, arc furnaces, or adjustable speed drive systems shall not cause voltage and/or current Total Harmonic Distortion levels greater than industry accepted levels on SPU's electric system at the point of delivery to the Customer's facility. The Customer shall disclose to SPU all nonlinear loads prior to connection. SPU may test the Customer's load to determine the THD levels. The guidelines for Total Harmonic Distortion included in the latest IEEE Std 519 "IEEE Recommended Practices and Requirements for Harmonic Control in Electrical Power Systems" shall be followed. It shall be the Customer's responsibility to assure that the THD requirements are met, including the purchase of any filtering equipment. Any load found not in

compliance with this policy shall be corrected immediately at the Customer's expense. If not corrected, SPU may disconnect service to the Customer's facility.

The Customer shall be liable for all damages, losses, claims, costs, expenses, and liabilities of any kind arising out of, caused by, or in any way connected with the application by the Customer of any nonlinear load operating with maximum THD levels in excess of the industry accepted levels. The Customer shall hold harmless and indemnify SPU from and against any claims, losses, costs of investigation, expenses, attorney's fees, damages, and liabilities of any kind arising out of the application of any nonlinear load operating with maximum THD levels in excess of industry accepted levels.

SHAKOPEE PUBLIC UTILITIES COMMISSION
ELECTRIC SERVICE RULES AND REGULATIONS
SECTION 800 – OVERHEAD SECONDARY SERVICE

Adopted by:
S.P.U.C. Resolution #
Dated

**SHAKOPEE PUBLIC UTILITIES COMMISSION
ELECTRIC SERVICE RULES AND REGULATIONS**

SECTION 800

Index

OVERHEAD SECONDARY SERVICE		Page No.
801	Maximum Transformer Size	49
802	Service Drop Conductors	49
803	Clearances	49
804	Point of Attachment	50
805	Service Entrance	50
806	Line Clearance	50

SECTION 800

OVERHEAD SECONDARY SERVICE

SPU will supply overhead secondary service (600 volts or less) at the voltages and under the conditions specified in other sections of this publication. The service entrance location will be specified by SPU. This section includes information on distribution transformer size, overhead service drop and connections to the Customer's premise or equipment. Metering and Customer equipment requirements are covered in other sections of this publication. The requirements of this section apply to all residential, commercial and industrial customers.

801 Maximum Transformer Size

801.1 The maximum overhead transformer size installed by SPU will be one 75 kVA transformer for a single phase application, two-75 kVA transformers or three-75 kVA transformers for three-phase applications. If a larger transformer size is required, it shall be a pad-mounted type.

801.2 One or more secondary services may be supplied from a transformer; the number of services from a transformer shall be determined by SPU depending upon the application.

802 Service Drop Conductors

802.1 The service drop for new services will be a twisted wire triplex (three wires) or quadplex (four wires) configuration from the distribution system to the point of attachment on the Customer's premises.

802.2 Existing services may be either a triplex or open wire configuration. At SPU's option, a service may be changed from an open wire to a triplex or quadplex.

803 Clearances

803.1 The service drop must be so located that the minimum clearances as specified in the latest edition of the National Electric Safety Code are maintained. See drawing No. 3 for a typical overhead service installation.

803.2 Service drop conductors installed above or near a swimming pool shall meet the distance requirements as specified in the latest edition of the National Electric Safety Code, Part 2, Safety Rules for Overhead Lines.

804 Point of Attachment

A solid point of attachment for supporting the service drop on the building shall be provided by the Customer at a point that will comply with previously stated clearances. Where the required heights and clearances cannot be maintained by a point of attachment on the building, the Customer shall provide a service mast which is of a permanent nature and of sufficient strength to support the service drop at the required minimum clearance. Two inch or larger galvanized iron conduit or 3 inch or larger rigid aluminum conduit shall be used. SPU reserves the right to decline to connect its service drop to an extension support which, in its judgment, constitutes a hazard to life or property. In cases where it is not possible to properly anchor an overhead service, the Customer may be required to install an underground service.

805 Service Entrance

The Customer's service entrance wiring shall terminate at a point so located that the service drop from supply lines will not interfere with windows, doors, awnings, drainpipes, or other parts of the building or other obstructions so that only one bracket is required.

806 Line Clearance

Trees located near overhead distribution lines and services will be periodically trimmed by SPU in order to maintain a reliable distribution system. Trees and shrubs will be trimmed back 6-8 feet from overhead conductors and service lines. Trimming may also be necessary in order to restore service after a storm. The trimmed brush will normally be chipped and removed, however, in storm situations when there is much tree damage, it may be left in order to expedite restoration of the entire system.

SPU personnel will discuss the planned trimming with the affected customers before the work is done.

Customers are reminded to use extreme caution when trimming trees near overhead power lines. Contact SPU's Electric Service Department for assistance in getting your project done safely.

SHAKOPEE PUBLIC UTILITIES COMMISSION
ELECTRIC SERVICE RULES AND REGULATIONS
SECTION 900 – UNDERGROUND SECONDARY SERVICE

Adopted by:
S.P.U.C. Resolution #
Dated

**SHAKOPEE PUBLIC UTILITIES COMMISSION
ELECTRIC SERVICE RULES AND REGULATIONS**

SECTION 900

Index

UNDERGROUND SECONDARY SERVICE		Page No.
901	Undergrounding in New Residential Developments	53
902	Residential Undergrounding in Overhead Areas	53
903	Underground Service to Commercial & Industrial Customers	54
904	Secondary Connection Cabinets	55
905	Transformer Clearances	55
906	Winter Construction	55

SECTION 900

UNDERGROUND SECONDARY SERVICE

901 Undergrounding in New Residential Developments

SPU requires the complete underground installation of the distribution system in all residential zones, except in those cases where it is determined that underground installations are technically unfeasible.

SPU will designate a junction point for the connection of the Customer's secondary underground service lateral. The junction point will be a service pedestal or the terminals of a pad-mounted transformer. In general, SPU will install, own, operate, and maintain all facilities on the source side of the junction point, including the junction enclosure and connections; and the Customer will install, own, operate, and maintain all secondary cables, conduit, and related service equipment specified in other sections of this publication on the load side of the junction point. See drawing No. 4 for a typical underground service. The developer of a new subdivision is responsible for installing SPU-supplied road crossing conduits, according to SPU specifications. Drawing No. 5 shows a typical conduit crossing installation.

Junction points will be located within SPU's easement area along or near a front or rear property line unless it is necessary or desirable to designate locations which are closer to the metering points. In such cases, the Customer will be charged for the installed cost of any additional lengths of underground distribution cable and conduit from the property line to the junction point. Such charges shall be in addition to any other charges specified herein.

SPU's distribution system will normally be installed in the Right-of-Way or within utility easements provided by the Customer as a part of the recorded property plat. SPU reserves the right to require additional easements as it deems necessary. All utility easements requested by SPU are to be granted by the Customer at no cost to SPU.

902 Residential Undergrounding in Overhead Areas

Customers residing in residential zones served by overhead lines may request underground service. Customers intending to relocate, upgrade, or replace an existing overhead service may request underground service. In either case, the Customer shall install, own, operate, and maintain the facilities up to the junction point, usually on a pole. In addition, the Customer will be charged an amount which reflects any additional cost incurred by SPU in providing service to the junction point. All such

charges must be paid by the Customer before SPU will commence installation of the necessary facilities.

903 Underground Service to Commercial and Industrial Customers

SPU requires the underground installation of primary and secondary distribution service laterals to new commercial and industrial structures. A junction point will be designated for the connection of the Customer's secondary underground service lateral. The junction point will normally be the secondary terminals of a pad-mounted transformer placed at mutually agreeable location.

SPU will install, own, operate, and maintain the primary underground cable, distribution transformer, and secondary connections. Transformers shall be located within 10 feet of a street, driveway, or parking area of 5 ton load rating. The transformer shall be located in an area that allows unrestricted access by SPU personnel at all times. It may not be located behind a fence or gate that is controlled by others. The Customer will be required to install SPU-supplied PVC conduit for the primary cables in areas under driveways, parking lots, and other hard surfaced areas. See drawing No. 7 for details on the placement of conduit. Any adjustment to the grade of SPU's distribution plant, after it has been installed to the specified grade, will be at the Customer's expense.

The Customer shall install, own, and maintain a concrete transformer pad built to SPU specifications. If the transformer is located in an area where it may be subject to physical damage by vehicles or other equipment, steel bollards, supplied and installed by the Customer, will be required to protect it.

The Customer shall install, own, and maintain all secondary cables, conduits, and cabinets from the transformer secondary terminals to the building service entrance. The secondary connections will be made by SPU. Metering installation and ownership shall be in accordance with Section 600.

The maximum number of secondary cables allowed to be installed in the secondary compartment of a transformer is six (6) per phase and neutral. The maximum conductor size allowed is 500 MCM copper or 750 MCM aluminum. If more cables are needed, a connection cabinet shall be used as described below. Shakopee Public Utilities' Electric Superintendent may allow more conductors per phase on a case by case basis.

904 Secondary Connection Cabinets

Where secondary cabinets are used, the following apply:

904.1 Cabinets will be suited to the installation and meet SPU and National Electrical Code requirements.

904.2 Cabinets shall be constructed with provisions for bar-type current transformers.

904.3 Conduits and conductors shall be provided and installed underground by the Customer between the transformer terminals and the connection cabinet.

905 Transformer Clearances

Minimum clearances from buildings and other structures must be maintained in the placement of transformers. See drawing No. 8. Transformers should be installed in such a way that allows the movement of air around them for cooling. Any screening for aesthetic reasons must not restrict the movement of air for cooling and it must not limit access by SPU personnel and equipment.

A clear space of 10 feet in front of the doors and 2 feet on the other sides of transformers and switches must be maintained. This space may not have a slope greater than 8/1. Shrubbery and trees for screening the equipment may be planted outside of the clear space area. See drawing No. 9 in the Appendix for details of clear zones.

906 Winter Construction

Underground cables will not normally be installed in frozen ground. If, however, they are installed in these conditions at the Customer's request, the installation will be subject to a winter installation charge.

**SHAKOPEE PUBLIC UTILITIES COMMISSION
ELECTRIC SERVICE RULES AND REGULATIONS**

SECTION 1000 – PRIMARY SERVICE

**Adopted by:
S.P.U.C. Resolution #
Dated**

**SHAKOPEE PUBLIC UTILITIES COMMISSION
ELECTRIC SERVICE RULES AND REGULATIONS**

SECTION 1000

Index

PRIMARY SERVICE

Page No.

1000 Primary Service

58

SECTION 1000

PRIMARY SERVICE

Primary service is available for Customers whose load and/or load arrangement do not allow efficient service at secondary voltage. The Customer must provide a suitable cabinet in which to terminate SPU's cables and mount metering equipment. Service is available at the available primary circuit voltage in the area, either 12,470Y/7200 volts or 13,800Y/7970 volts. The point of delivery will normally be the terminals of SPU's cable in the Customer cabinet.

Customer owned cabinet must have provisions for looping of SPU's cable. If not looped, customer must provide SPU with a concrete encased duct bank to property line.

Primary Customers receive a cash discount of 5% on the amount of the monthly bill, with the discount applied to all charges except the power adjustment charge.

**SHAKOPEE PUBLIC UTILITIES COMMISSION
ELECTRIC SERVICE RULES AND REGULATIONS**

APPENDIX

**Adopted by:
S.P.U.C. Resolution #
Dated**

APPENDIX

Drawings No.

1. Multiple Metering Installation
 2. Smart Switch
 3. Typical Overhead Service
 4. Typical Underground Service
 5. Conduit Crossings
 6. Typical Joint Trench Layouts
 7. Conduit Placement
 8. Transformer Minimum Distances
 9. Clear Zones Around Pad-Mounted Equipment
-
- A. Summary of Developer Requirements for Electric Service
 - B. Summary of Property Owner Requirements for Electric Service
 - C. Summary of Customer Requirements for Electric Service

TYPICAL MULTIPLE METERING ARRANGEMENT

All equipment furnished and installed by customer

meters furnished and installed by SPU

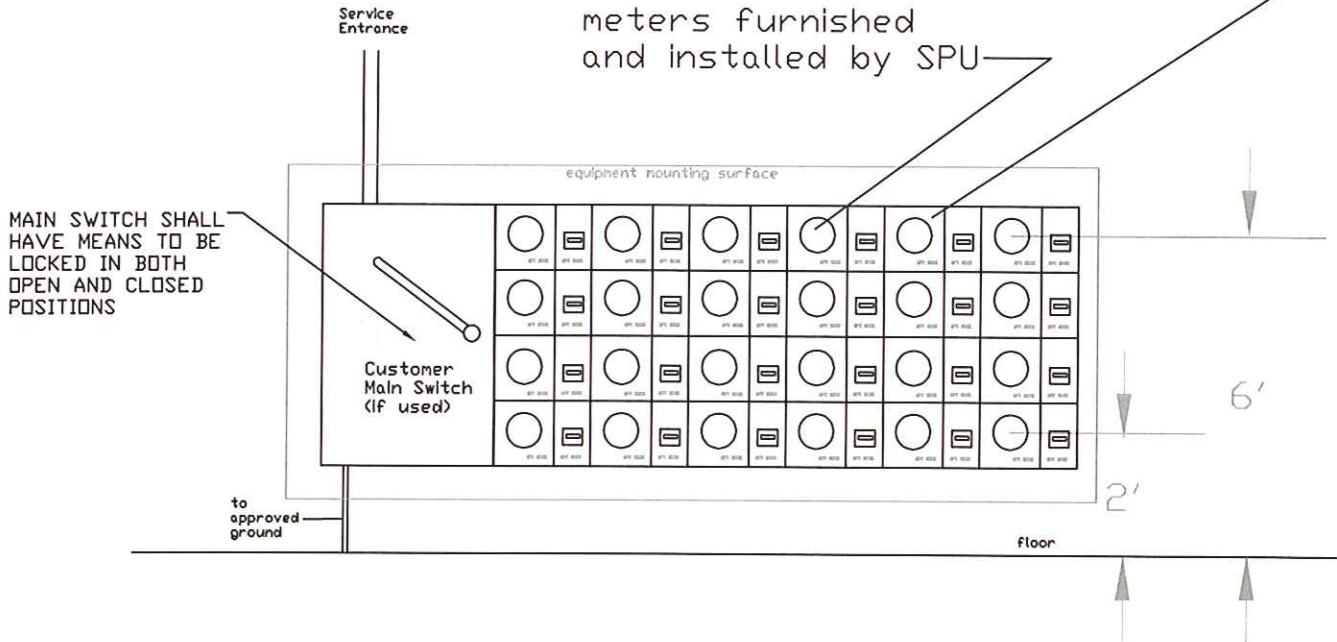

Center of Meters shall be between 2' and 6' from the floor

Meters shall be permanently labeled with unit identification

Meters shall have individual lock-off capability

Meters shall be accessible to SPU and to customers

Labels shall be installed both on the socket cover and inside the socket

Labels shall be made of durable engraved metal or plastic and riveted, screwed or bolted to socket cover

TITLE		
MULTIPLE METERING INSTALLATION		
SHAKOPEE PUBLIC UTILITIES		
DRAWN BY	CJF	DATE 10-11-18
CHECKED BY	GLD	DATE 10-11-18
APPROVED BY	JDA	DATE 10-12-18
RULES & REGULATIONS		DRAWING NO. 1

TYPICAL SMART SWITCH INSTALLATION

DURING LOAD CONTROL PERIOD, SIGNAL TO A/C COMPRESSOR IS INTERRUPTED

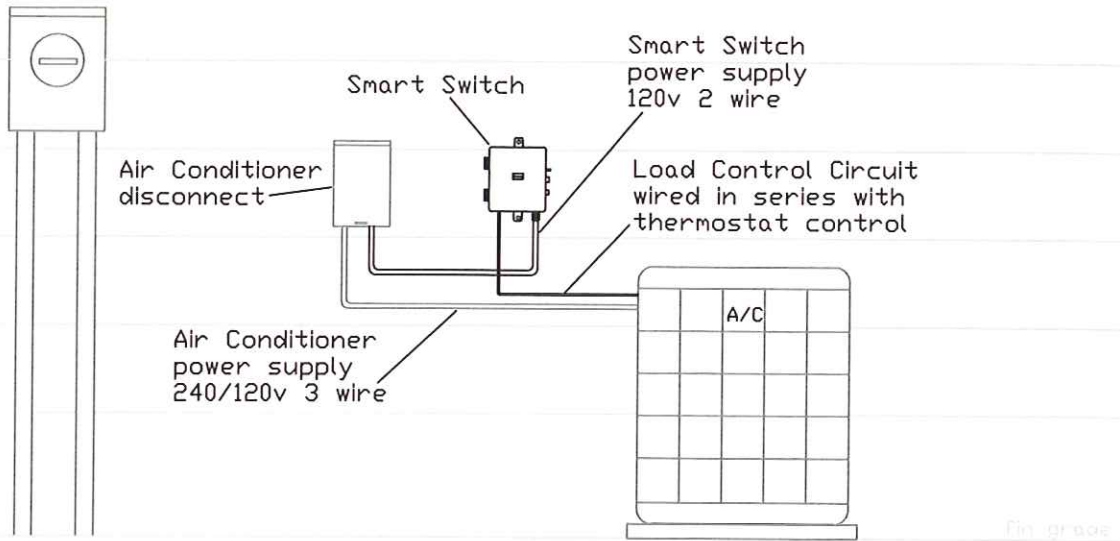

TITLE			SMART SWITCH INSTALLATION
SHAKOPEE PUBLIC UTILITIES			
DRAWN BY	JEK	DATE	03-08-07
CHECKED BY	GLD	DATE	10-11-18
APPROVED BY	JDA	DATE	10-12-18
RULES & REGULATIONS DRAWING NO.			2

TYPICAL OVERHEAD RESIDENTIAL SERVICE ENTRANCE AND METERING ARRANGEMENT, 240/120 VOLT

SPU SHALL OWN AND OPERATE ALL OVERHEAD ELECTRIC SERVICE CONDUCTORS UP TO THE CONNECTION AT THE MAST.
 CUSTOMER SHALL INSTALL, OWN AND MAINTAIN THE OVERHEAD MAST ON THE HOUSE.

MINIMUM CLEARANCES OF SERVICE LINE ABOVE GRADE

- 12' - AT BUILDING
- 16' - ABOVE DRIVEWAY
- 18' - ABOVE PUBLIC STREET

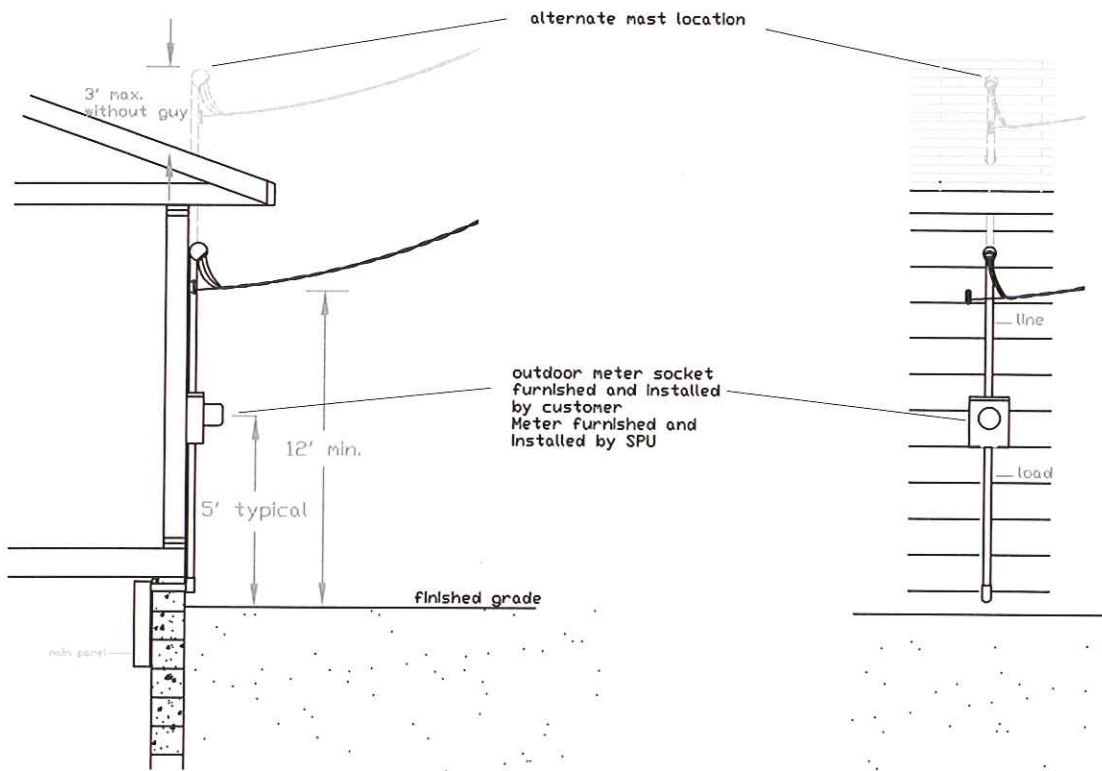

TITLE			TYPICAL OVERHEAD RESIDENTIAL SERVICE
			SHAKOPEE PUBLIC UTILITIES
DRAWN BY	CJF	DATE	09-13-18
CHECKED BY	GLD	DATE	10-11-18
APPROVED BY	JDA	DATE	10-12-18
RULES & REGULATIONS DRAWING NO.			3

TYPICAL UNDERGROUND RESIDENTIAL SERVICE ENTRANCE AND METERING ARRANGEMENT, 240/120 VOLT

ALL UNDERGROUND SERVICE CONDUCTORS ARE OWNED BY THE CUSTOMER UP TO THE DESIGNATED JUNCTION POINT NEAR THE PROPERTY LINE. UNDERGROUND SERVICE CONDUCTOR MUST MEET ALL APPLICABLE NEC AND NESC RULES.

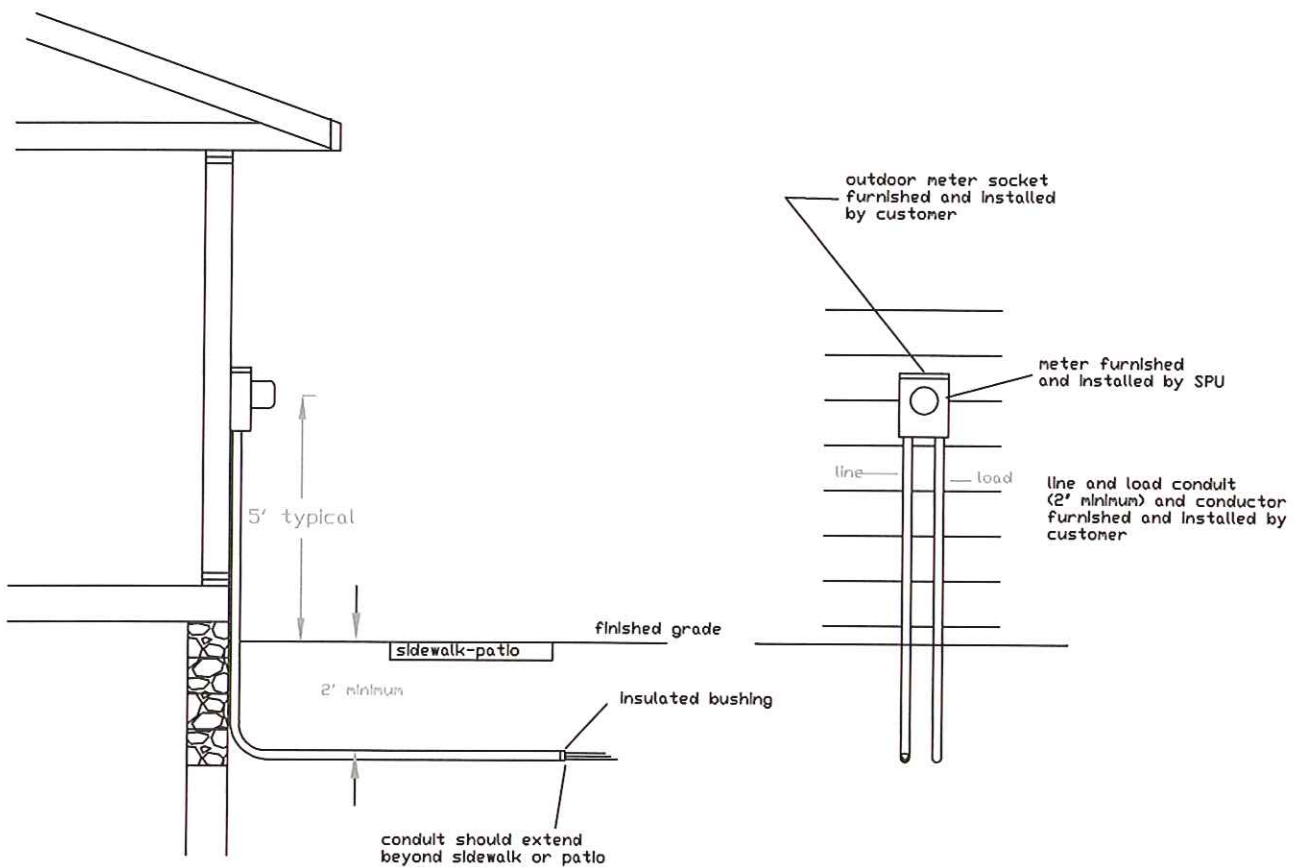

CUSTOMER MUST INSTALL CONDUCTORS A MAX 1FT FROM JUNCTION POINT. CUSTOMER MUST LEAVE 5FT COIL FOR CONNECTION. SPU SHALL CONNECT THE CONDUCTORS IN THE BOX

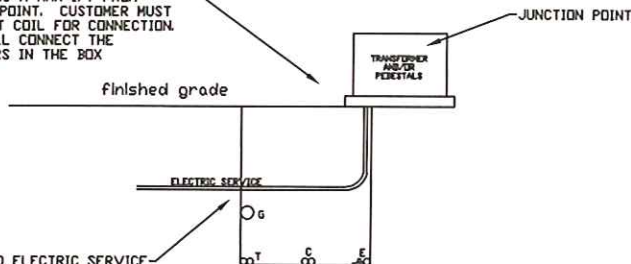

CUSTOMER OWNED ELECTRIC SERVICE CONDUCTORS MUST BE INSTALLED WITH 12' MIN VERTICAL CLEARANCE TO GAS MAINLINE. IF NECESSARY TO ACHIEVE THIS, SERVICE MUST EITHER BE INSTALLED IN PVC AND BURIED 18" DEEP OR SERVICE MUST BE INSTALLED UNDER GAS MAIN

TITLE			TYPICAL UNDERGROUND RESIDENTIAL SERVICE
			SHAKOPEE PUBLIC UTILITIES
DRAWN BY	CJF	DATE	09-13-18
CHECKED BY	GLD	DATE	10-11-18
APPROVED BY	JDA	DATE	10-12-18
RULES & REGULATIONS			4
DRAWING NO.			

PLAN VIEW - TYPICAL INTERSECTION

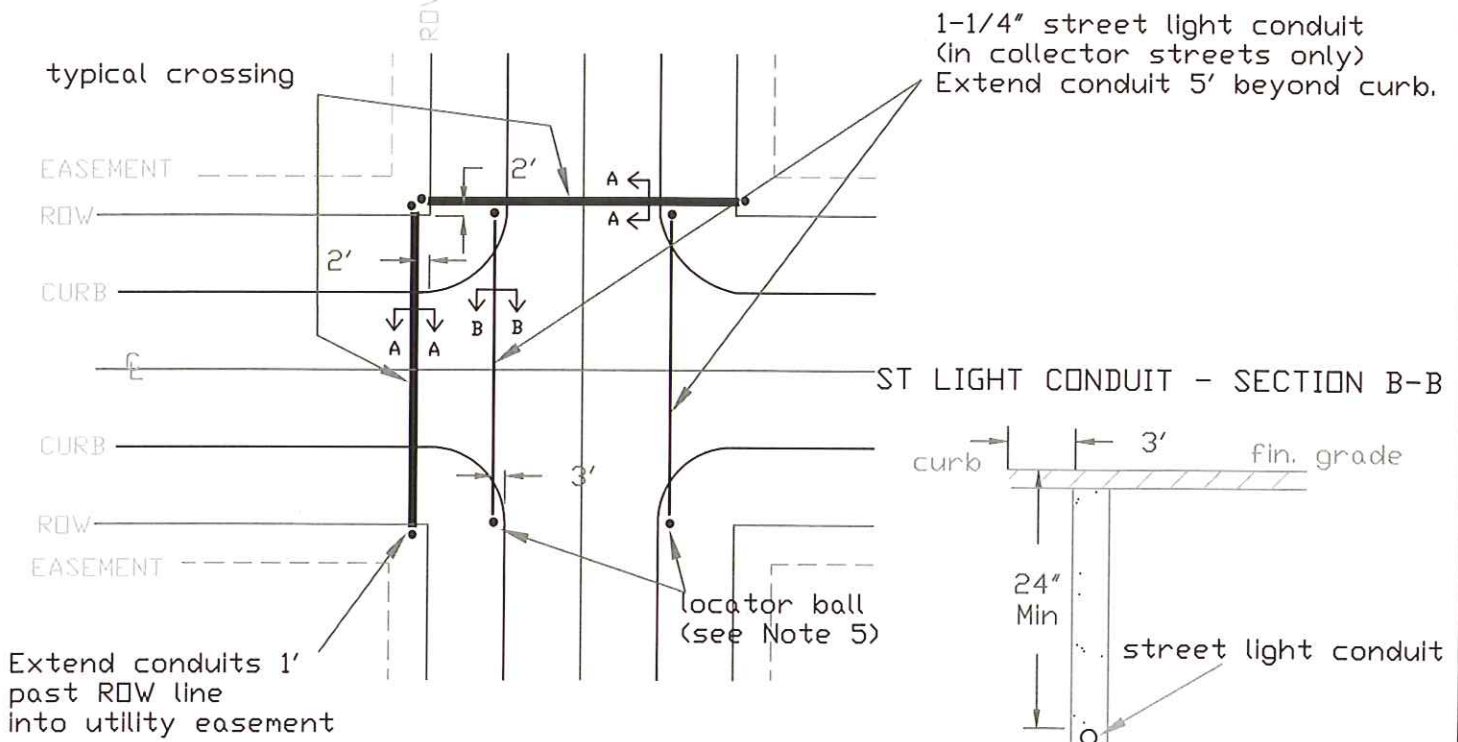

CROSSING DETAIL - SECTION A-A

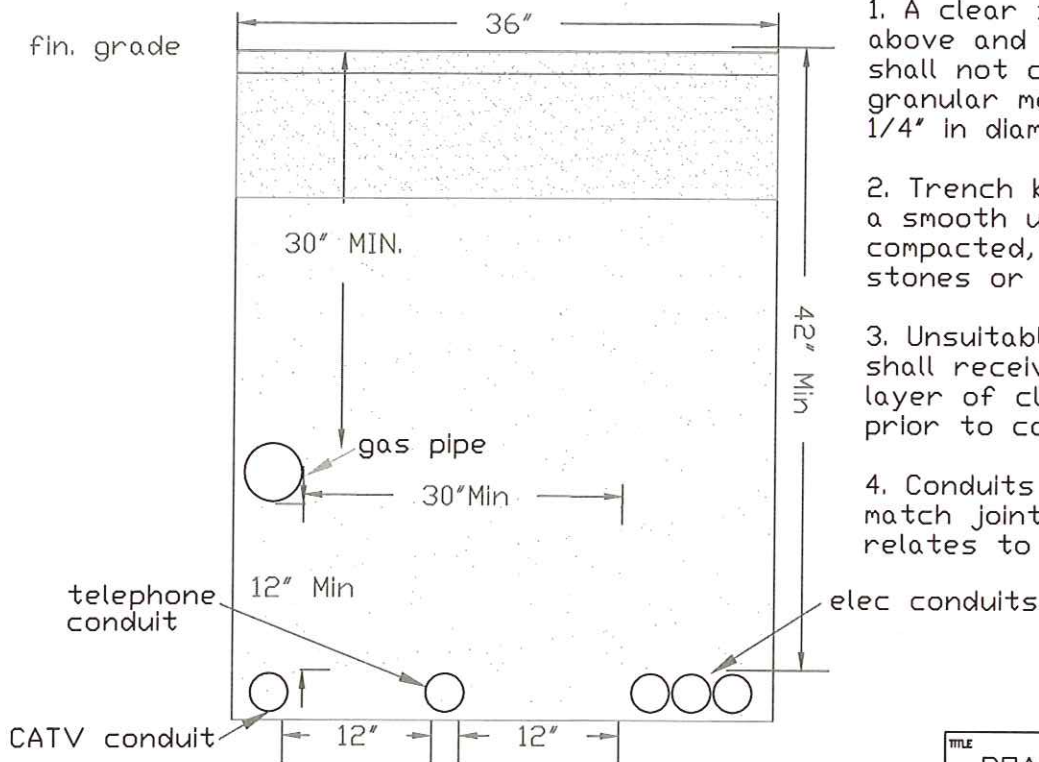

1. A clear zone, approximately 12" above and around all utility lines, shall not contain backfill granular material larger than 1/4" in diameter.
2. Trench bed shall be of a smooth uniform grade, compacted, and free of stones or protrusions.
3. Unsuitable trench beds shall receive a 2" compacted layer of clear zone material prior to conduit placement.
4. Conduits should be placed to match joint trench detail as it relates to location in trench.

TITLE		
ROAD CROSSING CONDUITS		
SHAKOPEE PUBLIC UTILITIES		
DRAWN BY	DATE	RULES & REGULATIONS DRAWING NO. 5
CJF	09-13-18	
CHECKED BY	DATE	
GLD	10-12-18	
APPROVED BY	DATE	
JDA	10-12-18	

UTILITY JOINT TRENCH
WITH GAS HOUSE SIDE
(MEETS CITY OF SHAKOPEE DETAIL 5010)

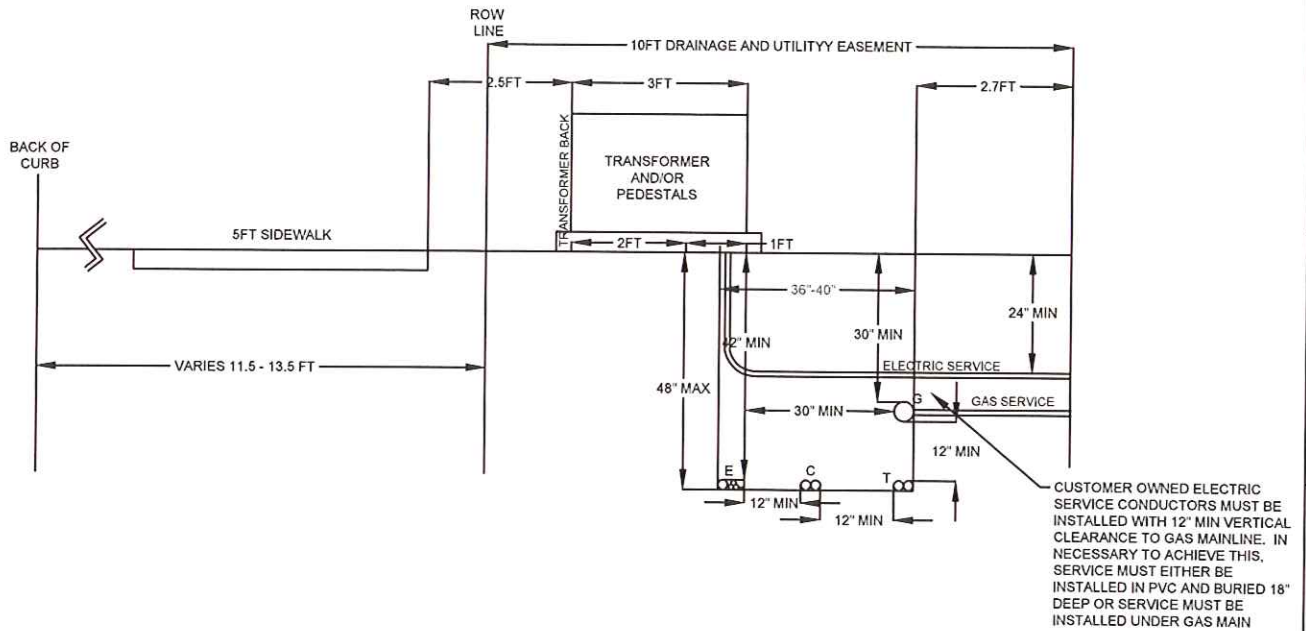

UTILITY JOINT TRENCH
WITH GAS ROAD SIDE
(MEETS CITY OF SHAKOPEE DETAIL 5009)

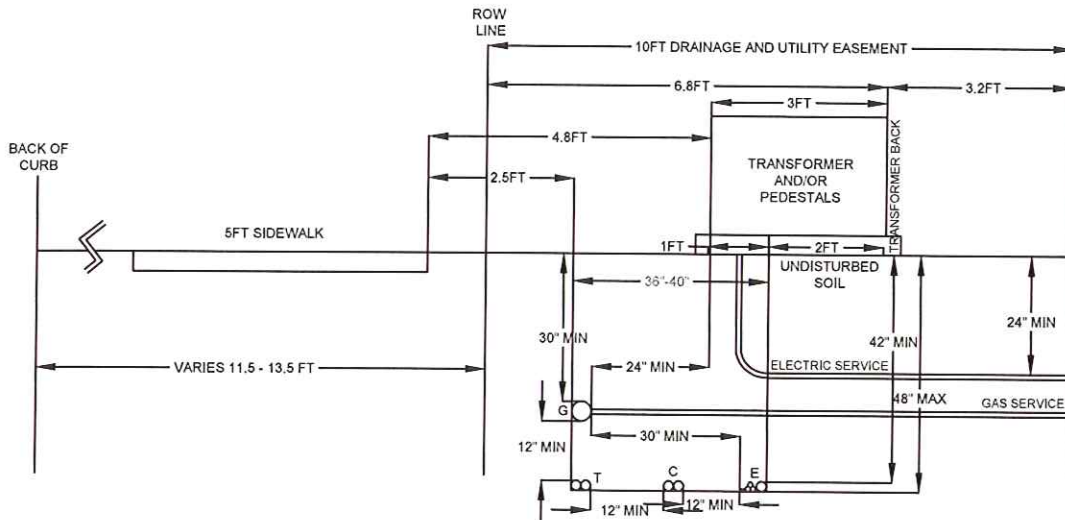

1. A clear zone, approximately 12" above and around all utility lines, shall not contain backfill granular material larger than 1/4" in diameter.
2. Trench bed shall be of a smooth uniform grade, compacted, and free of stones or protrusions.
3. Unsuitable trench beds shall receive a 2" compacted layer of clear zone material prior to wire/conduit placement.

TITLE		
TYPICAL JOINT TRENCH LAYOUTS		
SHAKOPEE PUBLIC UTILITIES		
DRAWN BY	DATE	RULES & REGULATIONS DRAWING NO. 6
CJF	09-13-18	
CHECKED BY	DATE	
GLD	10-11-18	
APPROVED BY	DATE	
JDA	10-12-18	

CONDUIT ARRANGEMENT ON CUSTOMER PROPERTY

These conduit arrangements provide for physical separation of circuit segments in order to minimize the possibility of damage to more than one circuit segment at a time due to a dig-in or cable failure.

All conduits must have a minimum of 36" cover

No conduit shall have more than 48" cover

The radius of 90 degree bends shall be no less than 36"

Option 1

1A. 12" trench

1B. 12" trench

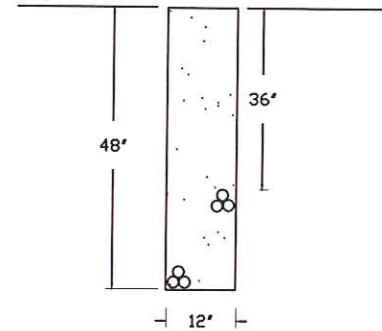
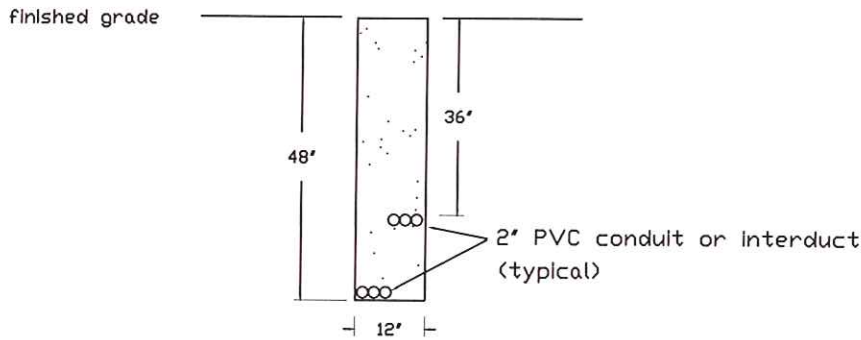

Option 2

2A. 24" trench

2B. 20" trench

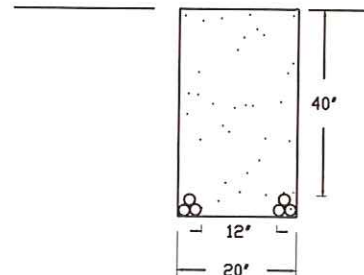
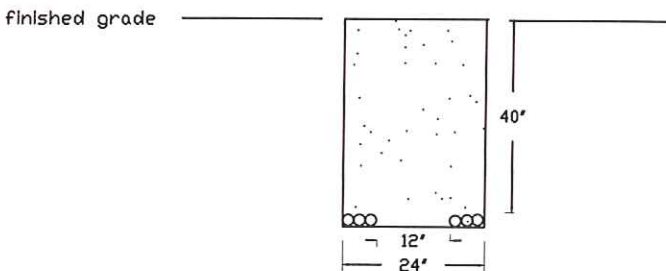

NOT TO SCALE

1. A clear zone, approximately 12" above and around all conduits, shall not contain backfill granular material larger than 1/4" in diameter.
2. Trench bed shall be of a smooth uniform grade, compacted, and free of stones or protrusions.
3. Unsuitable trench beds shall receive a 2" compacted layer of clear zone material prior to conduit placement.

TITLE		
PRIMARY CONDUCTOR CONDUIT INSTALLATION ON CUSTOMERS PROPERTY		
SHAKOPEE PUBLIC UTILITIES		
DRAWN BY	DATE	RULES & REGULATIONS DRAWING NO. 7
CJF	09-14-18	
CHECKED BY	DATE	
GLD	10-11-18	
APPROVED BY	DATE	
JDA	10-12-18	

Location of Transformers Near Buildings and Building Features

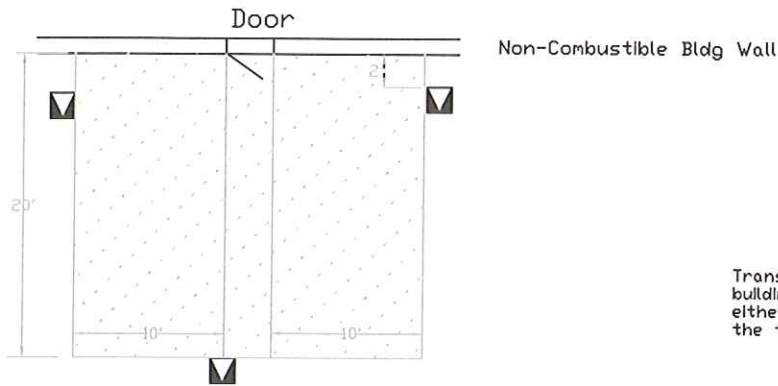

Transformers shall not be located closer than 2' to a building nor in a zone extending 20' outward and 10' to either side of a door.

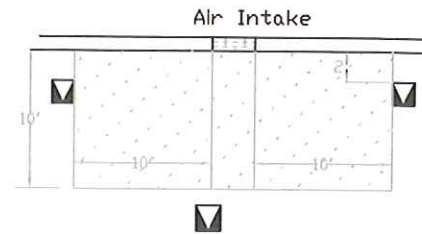

Transformers shall not be located closer than 2' to a building nor within a zone extending 10' outward and 10' to either side of an air intake opening located at the level of the transformer.

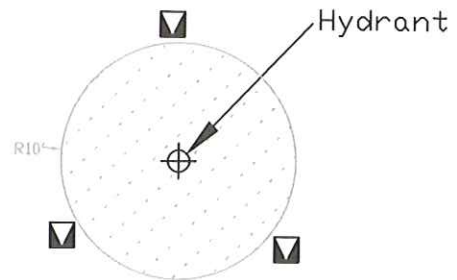

Transformers shall not be located within an 10' radius circle centered on a fire hydrant.

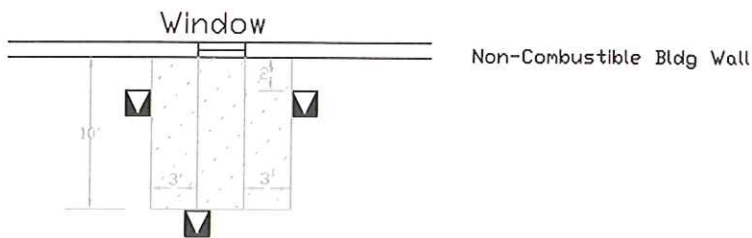

Transformers shall not be located closer than 2' to a building nor within a zone extending 10' outward and 3' to either side of a building window or opening other than an air intake.

Transformers may be shielded with non-combustible barriers when space is limited

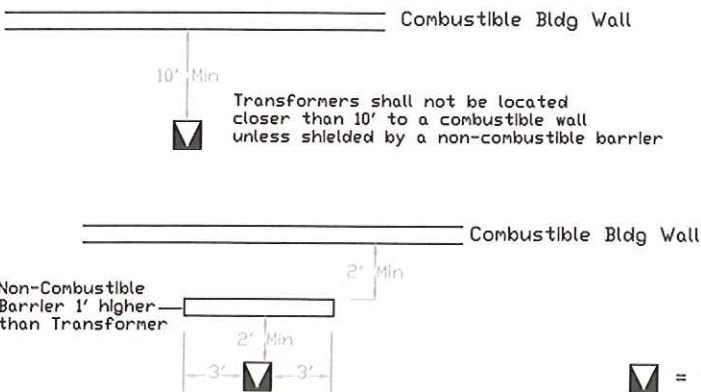
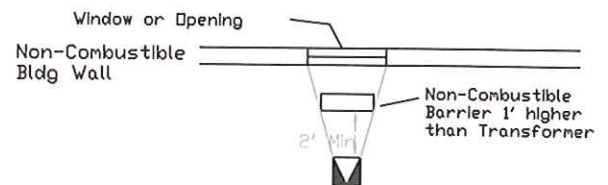
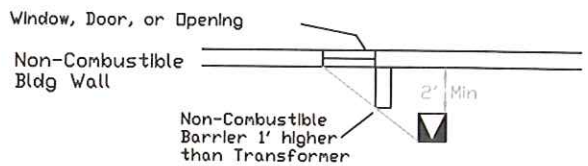

Definitions

Non-Combustible Walls - wood framed brick veneered, metal clad steel framed, asbestos-cement-board metal framed, and masonry

Combustible Walls - wood and metal clad wood framed

TITLE		
TRANSFORMER LOCATIONS		
SHAKOPEE PUBLIC UTILITIES		
DRAWN BY CJF	DATE 09-14-18	RULES & REGULATIONS DRAWING NO. 8
CHECKED BY GLD	DATE 10-11-18	
APPROVED BY JDA	DATE 10-12-18	

CLEAR ZONE REQUIREMENTS

A clear zone that is free of plantings and obstructions must be maintained around transformers and switches for operations, inspection, and cooling.

The clear zone shall extend out 3' from the sides and 10' from the doors of the equipment. The maximum slope in the clear zone shall be 8/1.

Locate utility cables before placing plantings near transformers and switches, outside of the clear zone.

Do not place plantings directly above utility cables.

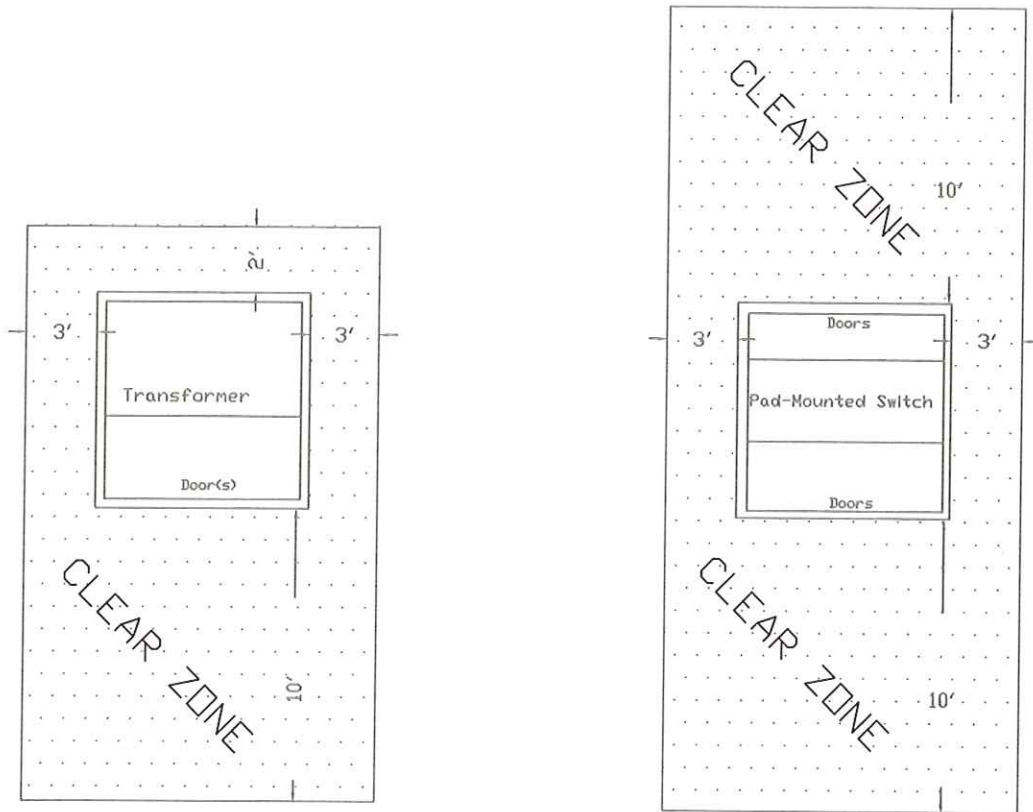

OPERATING CLEARANCE REQUIREMENTS AROUND EQUIPMENT		
SHAKOPEE PUBLIC UTILITIES		
DRAWN BY CJF	DATE 09-14-18	RULES & REGULATIONS DRAWING NO. 9
CHECKED BY GLD	DATE 10-11-18	
APPROVED BY JDA	DATE 10-12-18	

APPENDIX A

Summary of Developer Requirements for Electric Service

1. The developer shall submit a written request for electric service.
2. The developer shall enter into an Electric Distribution Agreement.
3. The developer shall pay a cash deposit equal to 100% of SPU's estimate of the contribution in aid of construction cost, prior to installation. The developer shall be responsible for all associated costs as described in the agreement. If the deposit is in excess of these costs, the amount will be returned at the end of the project.
4. The developer shall grant any necessary easements at no cost to SPU for SPU's electric system prior to installation.

APPENDIX B

Summary of Property Owner Requirements for Electric Service

1. The property owner shall submit an application for service.
2. The property owner shall adhere to all of the Electric Service Rules and Regulations as adopted by the Utilities Commission.
3. The property owner shall grant any necessary easements at no cost to SPU for SPU's electric system prior to installation.

APPENDIX C

Summary of Customer Requirements for Electric Service

1. The customer shall sign an application for utilities.
2. The customer shall pay a deposit equal to two months estimated usage charges, before service is provided.
3. The customer shall adhere to all of the Electric Service Rules and Regulations as adopted by the Utilities Commission.